

Lifetime Warranty Camera Head Moisture Ingress



Advanced Optics

- Superior 1080p image quality
- Powerful 30x optical zoom with 12x digital zoom (360x total)
- Image defog/dehaze analytics
- Electronic image stabilization (EIS)
- Dark scene enhanced intensity
- Bright source whiteout reduction
- Presets, tours, sectors and privacy zones

Rugged Construction

- Operates in hurricane force winds
- Built-in electrical transient/surge protection to CISPR 24 levels
- Precision positioning of 0.05°
- Pressurized IP68 Camera Head
- NEMA TS2 temperature range, -40°C to 75°C
- Three Year Standard Warranty
- Lifetime Warranty on moisture ingress into camera head enclosure

Installation and Interoperability

- ONVIF Profile S compliant
- NTCIP 1205 compliant
- Hybrid IP/analog video-serial PTZ operation
- H.264 Base/Main/High profiles and MJPEG encoding
- Web server configuration, operation and viewing
- Inverted mounting capability
- Single CAT5e cable with PoE++
- Pendent, wall, pole and corner mounting bracket options

Command Core™ Action Engine

- Automated camera responses
- Preset/Tour activations
- Digital I/O triggers and actions
- Image snapshots with FTP/EMAIL delivery
- Built-in Configuration Wizards
- Three trigger queuing modes



CohuHD Costar's 4260HD camera positioning system combines crystal clear HD image quality, bandwidth efficient H.264 compression, smooth variable speed positioning and IP68 protection delivering the CohuHD quality and performance you expect!

The 4260HD provides full 1080p imaging with 30x optical zoom, delivering full frame rate HD images over the entire zoom range for very cost effective long-range surveillance applications.

True day/night technology using a removable IR cut filter produces exceptional low light sensitivity down to 0.00025 fc.

For installations subject to wind or vibration, electronic image stabilization assures steady, clear images.

The 4260HD includes defog/dehaze image processing, enhancing video performance

in foggy and hazy conditions encountered in surveillance and traffic monitoring applications.

The 4260HD includes variable hi-speed pan and tilt drive, with 360° continuous pan and 360° tilt. Fast positioning speeds result in 180° movements in less than 2 seconds.

Providing multiple video stream profiles, the 4260HD delivers up to 5 or more independently configured H.264/MJPEG streams as well as analog video output with serial RS422 camera PTZ control.

Use of the IP and analog output allows integration with analog systems today while providing a smooth transition to HD Video over IP tomorrow.

The 4260HD provides a full function web server, allowing complete administrative and operator control capabilities. Administrative features include configuring

network settings, user password assignments, setting video streaming properties, configuring camera imaging properties, defining presets and tours and assigning camera ID labels.

The RISE action engine generates automated system responses to input triggers including digital inputs, date/time schedules and repetitive timers that can activate output actions including presets, image snapshots with FTP/EMAIL uploads, OSD displays and digital outputs.

The 4260HD is designed to operate in harsh weather with its purged and pressurized IP67 enclosure protection. This eliminates the effects of water intrusion, pollutants and corrosives.

CohuHD delivers years of clean, reliable images and backs it with a world class three-year warranty.



RISE 4260HD Series with Command Core™

H.264 High-Definition, IP68 Camera Positioning System



CAMERA

Sensor	1/2.8" CMOS
Scanning	Progressive
Resolution	1,920 x 1,080
	640 x 360 @ 3x dig. zoom
Digital Formats	YUV 4:2:2 SMPTE 274M, BT.709, BT.1120, 1080p, 1080i, 720p
Frame Rate	30 fps
Camera Format	Day/Night (IR Cut Filter)
Day/Night Modes	Auto, Color, B/W
S/N Ratio	>50 db
Motion Detection	Off/On [Area of Detection]

SENSITIVITY

Standard	(f1.4, 1/30, 30 IRE)
Color	0.25 lux (0.025 fc)
B/W	0.024 lux (0.0024 fc)
Digital Slow Shutter	(f1.4, 1/2, 30 IRE)
Color	0.015 lux (0.0015 fc)
B/W	0.0015 lux (0.00015 fc)

OPTICS

Zoom Lens	30x, 4.4 to 132mm effective 264mm with 2x digital zoom
Aperture	f1.4 -> f4.6
HAFOV	63.4° to 2.1° @ 1920x1080 63.4° to 0.7° @ 640 x 360
Focus	Auto/Manual [Near, Far]
Focus Search	Normal, Bright, Point Source
Focus Sensitivity	Low, Normal, High
Iris	Auto/Manual [Open/Close]
Lens Speed	Three [Slow, Medium, Fast]
Digital Zoom	12x, Off/On [Depth]

IMAGE PROCESSING

Defog Mode	Off/Auto/Manual [3 Levels, Strength and Color Adj.]
Image Stabilization	Off/On
Enhanced Intensity	Off, Enhanced, Whiteout Reduction
Dynamic Range	>90dB Off/On [3 Levels, Normal, Combo, Contrast]
Back Light Comp	Off/On [Level Setting]
Shutter (AES)	Auto/Manual [1/2 -> 1/30,000]
Slow Shutter	Off/On [1/15->1/2] with Limit Setting
White Balance	Auto/Manual [Red/Blue Adjustment]
(WB) Modes	Normal, Mercury, Sodium Vapor
AGC	1 to 48db, Adjustable
Sharpness	Soft, Normal, Sharp, Sharpest
Noise Reduction	Normal, Medium, Strong, Fixed

IP STREAM

Video Streams	5 or more video streams dependent on available processing budget
Video Codec	H.264 Base, Main and High Profiles, MJPEG
Video Protocols	RTSP/RTP RTSP Interleave HTTP Tunneling RTP Multicast
Video Resolution	1080p, 720p, D1, VGA, CIF
Video Frame Rate	1 to 30 fps, 30 fps default
Video Data Rate	256Kbs to 8Mbs
Video Rate Cntrl	Variable or Constant
Video GOV	1 to 600, 30 default
Video Latency	Four frames (0.133 sec.)
Video Trans.	99.999% error free

NETWORK INTERFACE

Network Format	802.3u 100Base-T, MDI-X auto-sensing, full duplex
Network Protocol	TCP, UDP, IPv4, ICMP, DNS, IGMPv2/v3, DHCP, RTP, RTSP, RTCP, NTP, HTTP, SOAP, HTTPS ARP, FTP, SMTP, SNMP/NTCIP, Telnet. ONVIF Profile S
Media Players	VLC, Quick Time or any media player compliant with RFC 2326, 3984, 3550, 2435, ISO/IEC 13818-1
ONVIF	Profile S
Camera Protocols	ONVIF, NTCIP 1205, CohuT, CohuHD legacy
Security	4 Levels: Admin, Operator, User, Anonymous [User Name + Password], Digest Authentication
Updates	File upload over network using camera web server interface
Configurations	Stored in Non-Volatile Memory
Browsers	IE11, Firefox, Chrome

DIGITAL I/O INTERFACE

Digital Circuits	Four digital I/O circuits, user defined as either input or output
------------------	---

ANALOG INTERFACE

Video Format	NTSC or PAL
Serial PTZ	RS422, full/half duplex, 1,200 to 115k baud adjustment, data, stop and parity bit configuration.
Protocols	CohuHD Legacy, PelcoD, Ultrak, NTCIP 1205, A/D, FAST, Javelin

COMMAND CORE ACTION ENGINE

Input Triggers	Digital Input(s), Timer, Scheduler, Preset reached, PTZ move, Maintenance, User command
Output Actions	Activate digital output(s), FTP image, Send Email, Send Text, Activate Preset or Tour, Display OSD message
Trigger Queuing	User selectable mode. Processes output actions by trigger priority, first in, or last in.
Servers	Multiple FTP and EMAIL servers can be onfigured for use by camera system

ON SCREEN DISPLAY (OSD)

OSD Capacity	Up to 7 OSD Elements can be selected for display on video
OSD Elements	Text, Preset, Position, Compass, Date/Time, Sector, Maintenance, Action Event
OSD Characters	Up to 40 characters per text element
OSD Size	20 to 90 point, Increment of 10
OSD Color	White, Black, Green, Red, Blue
OSD Background	Transparent, Black
OSD Location	Upper Right/Left, Lower Right/Left, Center, Custom
Banner Display	On/Off, Top/Bottom, 4 OSD elements
Logo Display	BMP, PNG, GIF Format, [x,y] position, Transparency

PRIVACY MASKS

Capacity	Up to 8 Rectangular Masks.
Color	Red, orange, green, blue, purple, grey
Blur	Solid, fine, medium or coarse pixelated
Opacity	25, 50 or 75%
Brightness	4 levels of adjustment



Toll Free: 888-509-8455. Email: clientservice@integrys.com
www.integrys.com

RISE 4260HD Series with Command Core™

H.264 High-Definition, IP68 Camera Positioning System



POSITIONING DRIVE

Pan Range	360° continuous rotation
Tilt Range	360°
Preset Speed	Peak speed of 120°/sec 180° movement < 3 seconds
Manual Speed	0.1° to 45°/second
Speed Resolution	> 64 Variable speed levels
Repeatability	+/- 0.05°
Resolution	+/- 0.05°
Presets	Up to 256, Includes pan, tilt, zoom, focus, preset ID, I/O output state
Tours	Up to 256, Includes presets with dwell, speed, direction and recurrence properties
Auto Park	Returns to a preset or tour after timer expires, Timer Value [Off, 1 Minute to 999 Hours]
Features	Auto focus/iris on PTZ, Proportional PTZ, Video freeze on preset, High wind/vibration mode, Set north calibration, Inverted mounting mode

ELECTRICAL

Input Voltage	PoE++, 24Vac or 120Vac, model dependent
Power	30w, up to 60w with heaters ON
Voltage Range	NEMA standard TS 2-2003 section 2.2.7 tests C thru H
Transient/Surge Emmissions	Certified to CISPR 24 levels
Pigtail Cable(s)	Certified to CISPR 22 levels Approx. 24"

MECHANICAL

Weight	21.5 pounds (9.75 kg maximum)
Dimensions	Refer to dim. diagram
Construction	Powder Coated aluminum
Faceplate	Optically Correct Glass
Faceplate Wiper	Model Dependent, [On/Off,

Sunshield	Dwell, Time Out Settings] Included as standard
Inverted Mounting	Yes. Software selectable
Connectors	RJ45, AMP, MS, Model dependent
Color	Light Gray Cardinal Coating T241-GR142
IK10+	Camera System except optics faceplate.

ENVIRONMENTAL

Protection Rating	Camera - IP68, Pressurized with Dry Nitrogen, 3.5 psi. Positioner Body - IP66
Operating Temp	-40°F to 167°F (-40°C to 75°C) Per NEMA TS2 2.2.7
Heaters	Heaters are software controlled for managing proper internal temperature of camera system. The faceplate heater is ITO coated glass designed to maintain outer faceplate surface temperature above 32° (0°C) down to - 4°(-20C)
Humidity	Up to 100%
Vibration	Per NEMA TS2 para. 2.2.8. 5-30Hz sweep @ 0.5g applied in each of 3 mutually perpendicular planes.
Shock	Per NEMA TS2 para. 2.2.9. 10g applied in each of 3 mutually perpendicular planes
Corrosion	MIL-STD-810G, Method 509.5, Paragraph 4.5.2, ANSI NCSL Z540-1, ISO 17025:2005

EMC CERTIFICATIONS

AS/NZS CISPR 22:2009+A1:2010
CAN/CSA-CISPR 22-10
FCC Part 15B

EN 55022:2010+AC: 2011
EN 55024:2010
EN 61000-3-2:2006+A1:2009+A2:2009
EN 61000-3-3:2013
EN 61000-4-2: 2009
EN 61000-4-3: 2006 +A1:2008 +A2:2010
EN 61000-4-4: 2004
EN 61000-4-5: 2006
EN 61000-4-6: 2009
EN 61000-4-8: 2010
EN 61000-4-11: 2004
RoHS
SASO (Pending)

ACCESSORIES

Mounts	
Pedestal	7411542-001
Wall	8425-7
Pole	8503-0
Corner	8503-1
Parapat	8503-2
7.0" BC Plate	8481-9

Field Cables

CAT5e Cables
8194602-xxx [where xxx = 025, 055, 100, 150, 200, 250, 300, 328] denoting cable length in feet. Includes RJ45 connectors at each end of cable.

Accessory Cables
CA277, CA278 Series

Power Supply

7412007-003	PoE++, 60W, 110/220vac IP50, -34 to 74C
7411543-010	24Vac, 100VA, 110/220vac, IP66, -34 to 74C

WARRANTY

Three (3) years on camera and positioner system. Lifetime warranty on dome enclosure moisture ingress.

ORDERING INFORMATION - I.E. 426A-1100

Model Structure	Option #	Option Description
Product Series	426	RISE 4260HD Series IP68 Camera Positioner
Power and Connection Options	1	PoE++ Power, RJ45 Pigtail
	2	PoE++ Power, RJ45 Pigtail, Accessory Pigtail
	3	PoE++ Power, RJ45 Pigtail, MS Conn. Accessory Pigtail
	4	24 Vac Power, RJ45 Pigtail, Accessory Pigtail, Wires
	5	24 Vac Power, RJ45 Pigtail, Accessory Pigtail, MS Conn.
	6	24 Vac Power, MS Connector Pigtail
	7	120Vac Power, MS Connector Pigtail, Helios Pinout
	8	120Vac Power, MS Connector Pigtail, RJ45 Whip, i-Series Pinout
	9	120Vac Power, AMP Connector Pigtail, RJ45 Whip, i-Series Pinout
	A	120Vac Power, AMP Connector Pigtail, Helios Pinout
B	120Vac Power, AMP Connector Pigtail, Caltrans D11 Pinout	
	-	Model Number Separator
Camera Options	1	HD 1080p 30x Camera Modu
Housing Options	0	None
	1	Faceplate Wiper
Unassigned	00	Future Use

CLEARANCE

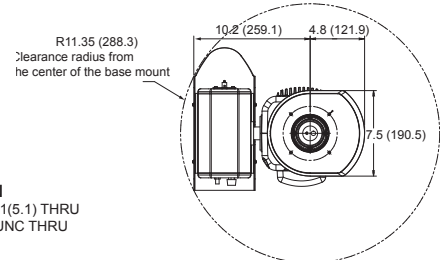

MOUNTING BOLT PATTERN

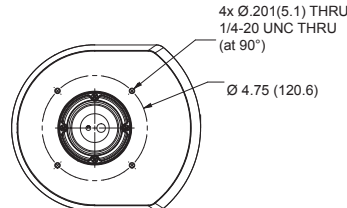

RISE 4260HD Series with Command Core™

H.264 High-Definition, IP68 Camera Positioning System



PIGTAIL CONFIGURATIONS (36" PIGTAILS)

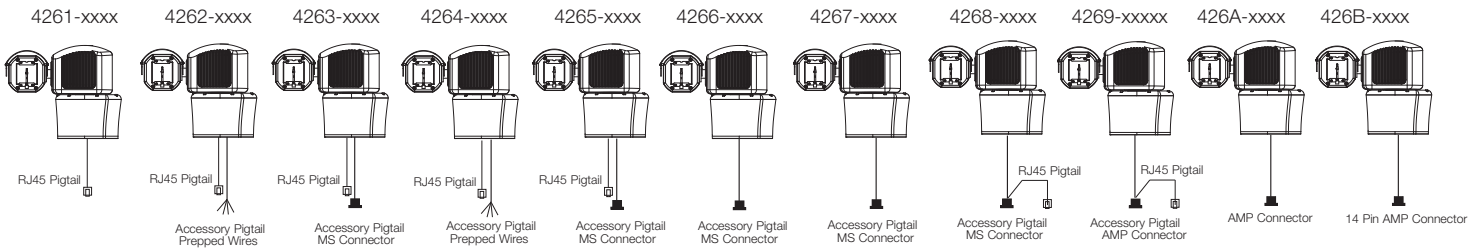

RJ45 IP67 Coupler, p/n 7610203-001. CAT5e/6/6a shielded cable with a 6mm-7mm O.D. is required for waterproofing.

DIMENSIONS FOR 4261 THROUGH 4266 MODELS

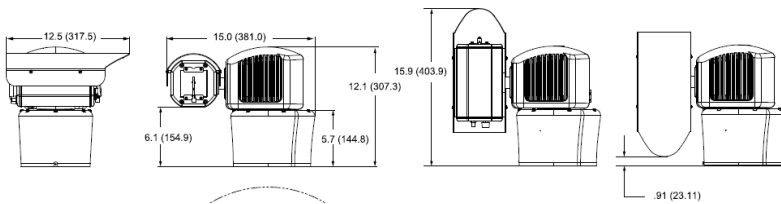

DIMENSIONS FOR 4267 THROUGH 426B MODELS

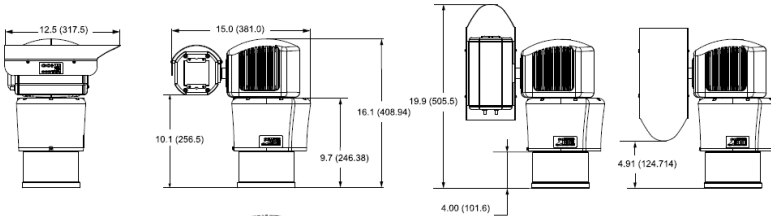

MOUNTING EXAMPLES

Pedestal Mount*

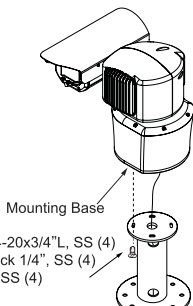

Bolt, Hex Head 1/4-20x3/4"L, SS (4)
Washer, Spring Lock 1/4", SS (4)
Washer, Flat 1/4", SS (4)
(supplied)

* Pedestal Mount
7411542-001 or
7411444-001 or
7411444-002

Pole Mount 8503-0

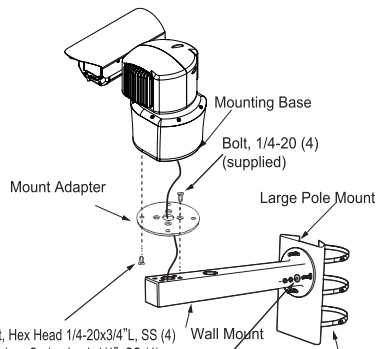

Bolt, Hex Head 1/4-20x3/4"L, SS (4)
Washer, Spring Lock 1/4", SS (4)
Washer, Flat 1/4", SS (4)
(supplied)

Washer, Flat 5/16", SS (8)
Washer, Spring Lock 5/16", SS (4)
Nut, Hex, 5/16", SS (4)

Wall Mount 8425-7

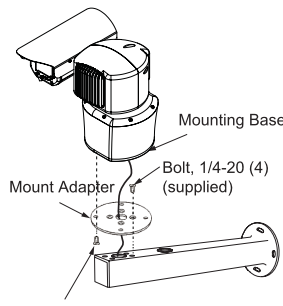

Bolt, Hex Head 1/4-20x3/4"L, SS (4)
Washer, Spring Lock 1/4", SS (4)
Washer, Flat 1/4", SS (4)
(supplied)



RISE Series IP Video Cameras

Rugged Innovation with Superior Endurance

The RISE Series IP video cameras are designed and built by CohuHD Costar for critical infrastructure applications demanding high-quality images, rugged construction and seamless interoperability. The RISE Series delivers advanced performance at unbeatable pricing.

About CohuHD Costar™

CohuHD Costar is a leading manufacturer of high-definition video systems designed to satisfy the demanding performance requirements for critical infrastructure applications. CohuHD solutions integrate the latest high-definition video imaging and compression technologies into ruggedized camera products for monitoring in critical, sensitive environments.